

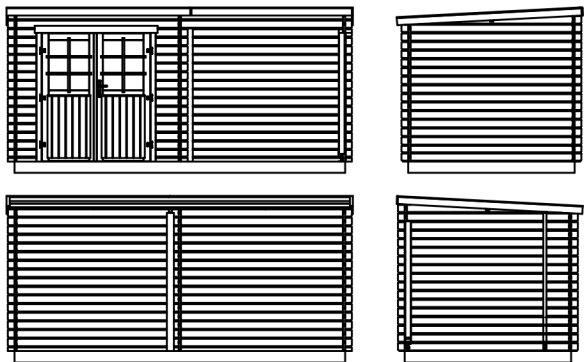

# Sophy 28(122) 2222+2222 PLT F0R1B0

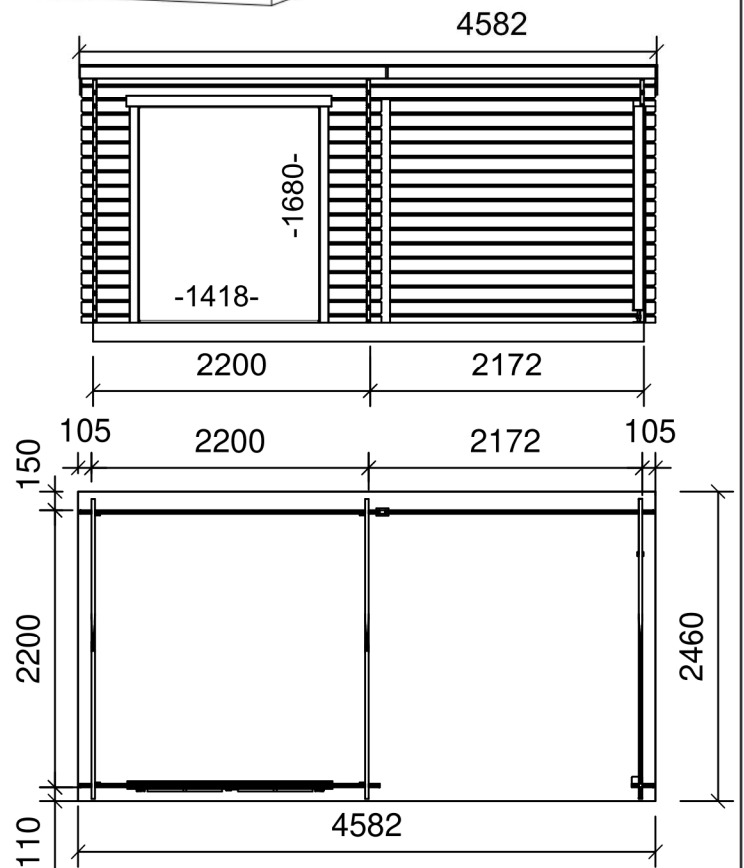

														
	Art. N.	Ean.N.	4,6-4,6m <sup>2</sup>	9,1-9,1m <sup>3</sup>	11,2m <sup>2</sup>									
	G2845450N	3760217462721				<table border="1"> <tr> <th>⊗ mm</th> <th>⊙ mm</th> <th>⓪ mm</th> <th>kg</th> </tr> <tr> <td>1150</td> <td>2640</td> <td>510</td> <td>495</td> </tr> </table>	⊗ mm	⊙ mm	⓪ mm	kg	1150	2640	510	495
⊗ mm	⊙ mm	⓪ mm	kg											
1150	2640	510	495											

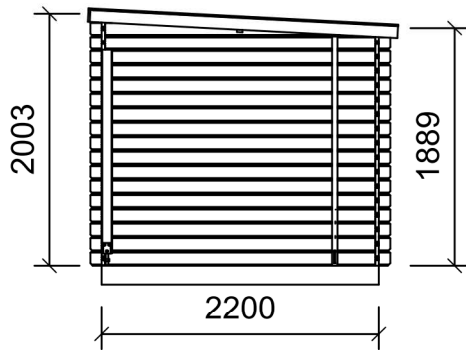
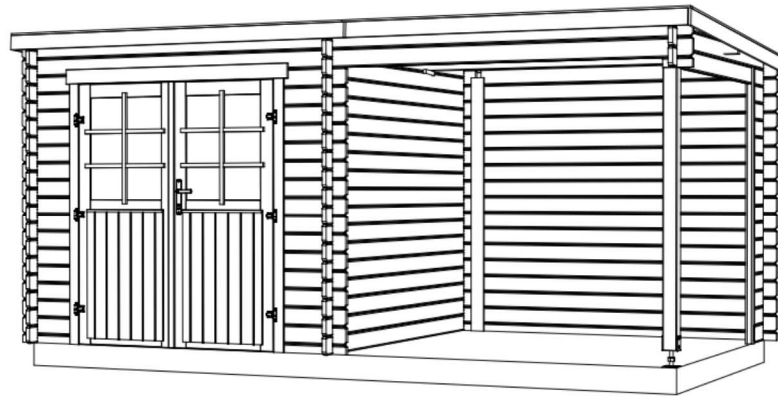
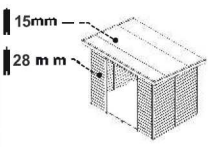
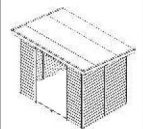
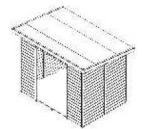
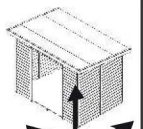
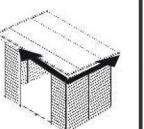
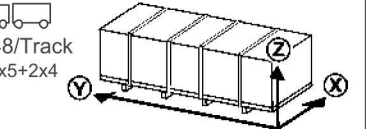